

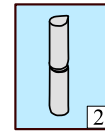

MIETO SISÄVÄLIOVI MIETO MELLANDÖRR

1. Karmiprofilli
2. Laakeroitu sarana
3. Karmin kiinnitysruuvi
4. Peitetulppa
5. Oviprofilli
6. Ovilevy 15 mm vaneri
7. Tarkastusikkuna
9. Säppisalpa
10. Oven alaputki
11. Laahuskumi
12. Ovilevyn kiinnitysruuvi
13. Peittotulppa
14. Kynnys
15. Kynnyksen kiinnitysruuvi

1. Karmiprofil
2. Gångjärn (lagrat)
3. Karmens fästskruv
4. Täckbricka
5. Dörrprofil
6. Dörrspegel 15 mm faner
7. Övervakningsfönster
9. Regel
10. Dörrrens nedre stomrör
11. Släppgummi
12. Dörrspegelns fästskruv
13. Täckbricka
14. Tröskel
15. Tröskelns fästskruv

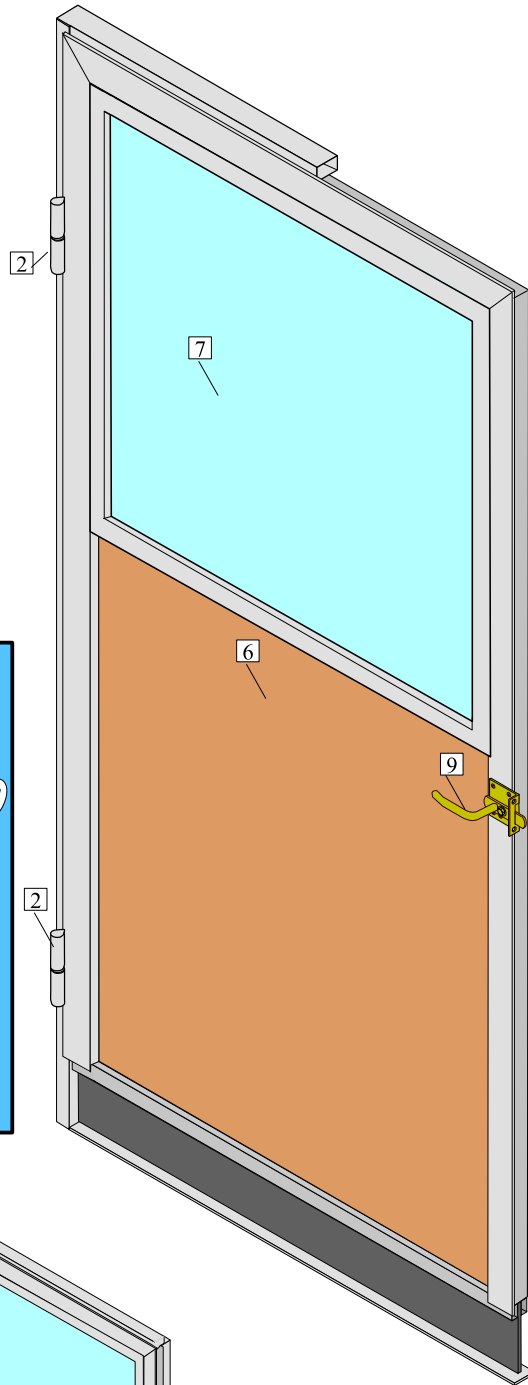
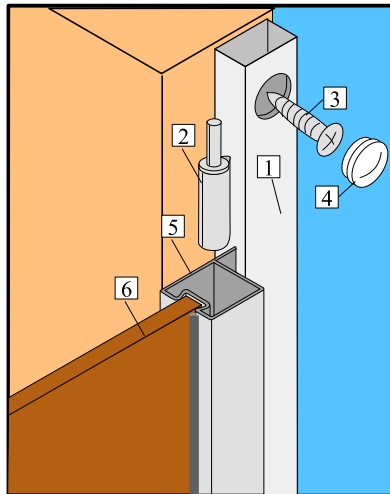

Laakeroitu sarana
Gångjärn (lagrat)

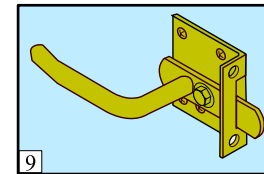

Säppisalpa
Regel

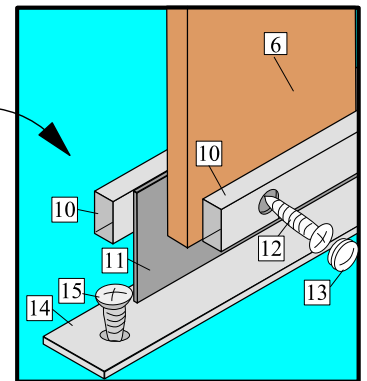

Oven alaosan rakenne
Dörrrens nedre konstruktion

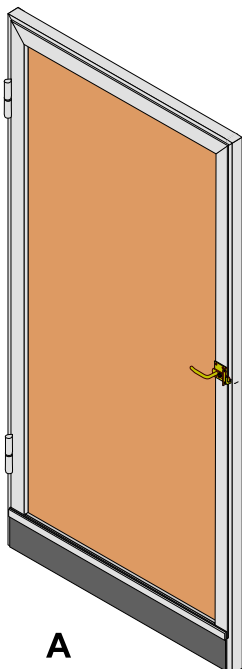

A

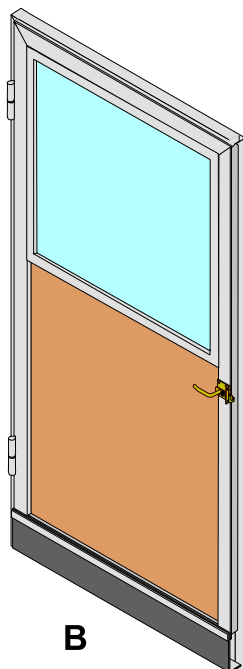

B



Miedon
Metalli Oy

61360 MIETO, Tel 06 450 2 325 Fax 450 3 647

www.miedonmetalli.fi